

Article number: 20262010

Description: E+G
Indexing plunger GN 817-4-4-G

Measures

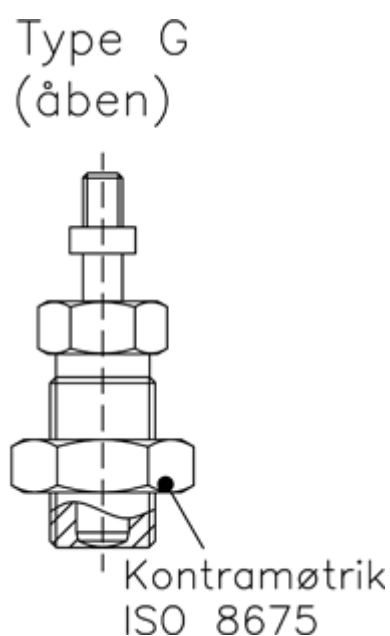
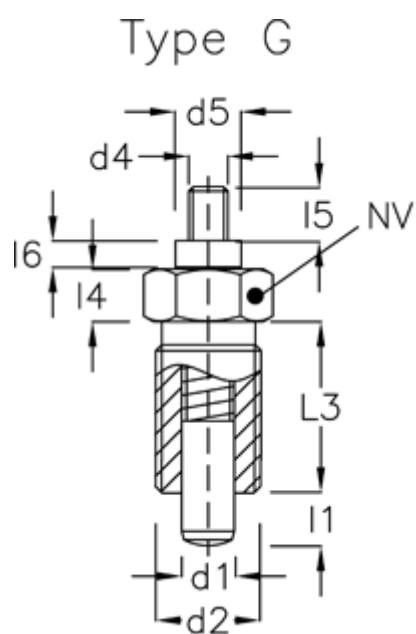

d1 = 4	l6	= 2.5
d2 = M8x1	NV	= 10
d4 = M3	Spring pressure N bottom	= 12.0
d5 = 7	Spring pressure N top	= 4.0
l1 = 4		
l3 = 16		
l4 = 5		
l5 = 4.5		